

Shower Pan Liners

- DURABLE, LIGHTWEIGHT SHOWER PAN PROTECTION
- CUSTOM MOLDED FOR ALL MINCEY SHOWER PANS
- TRIMMED FOR PERFECT FIT
- AVAILABLE FOR PURCHASE WITH ALL SHOWER PANS

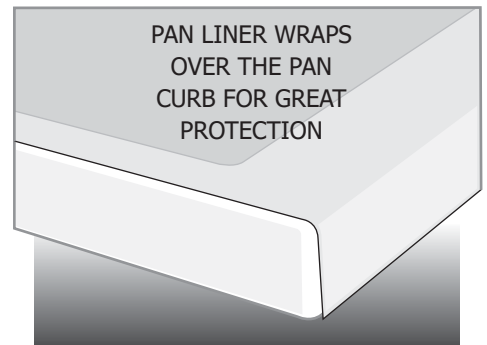

Protect your shower pans during construction!

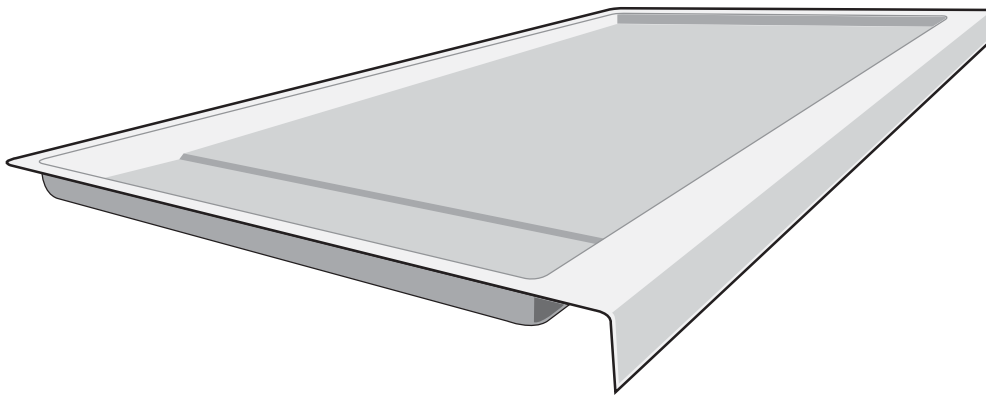

CUSTOM MOLDED TO FIT ALL MINCEY SHOWER PANS

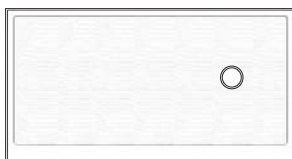

RECTANGLE

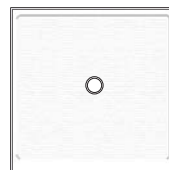

SQUARE

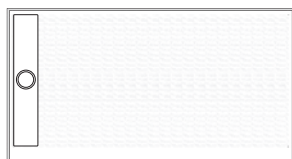

TRENCH DRAIN

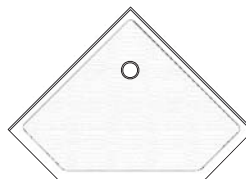

NEO-ANGLE



CURVED FRONT

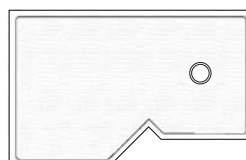

SPECIALTY

If you have any questions, please call
MINCEY MARBLE
CUSTOMER SERVICE
 at 1-800-533-1806