



Mincey Marble Mfg., Inc.

4321 Browns Bridge Road

Gainesville, GA 30504

Ph: 800.533.1806

Fx: 770.531.0935

www.minceymarble.com

**Installation Instructions for Mincey Marble Manufacturing's
Standard Cultured Marble Shower Pans**

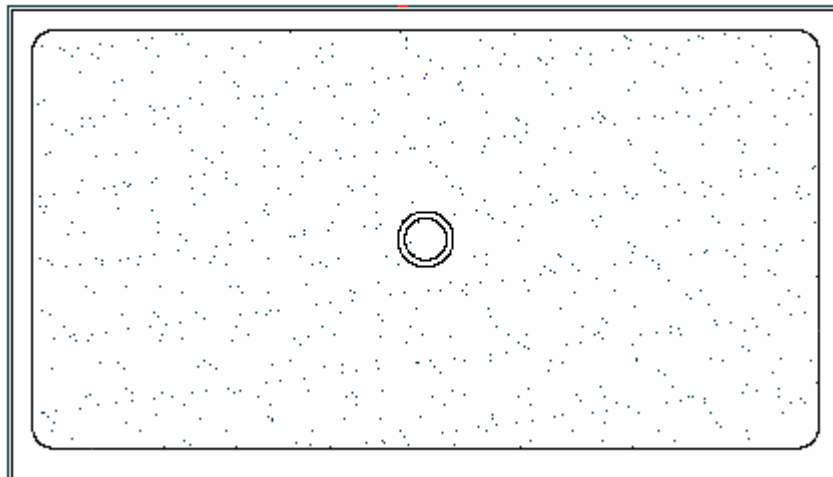

Part number: SP3460

All shower pans rest on sub-floors not finished floors. Mincey Marble's shower pans have been checked and leveled before leaving the shop. They have been custom designed to drain properly if installed on a level surface.

IMPORTANT: Do not use the integral flange or leak-proof fiberglass edges (whichever is applicable) to lift the pan. This is not a handle. The edging is critical to ensure that the pan will not leak in case there is a drain problem and water overflows the pan. This will keep water from getting into the wall.

INSTALLERS - Please Note- most floors are not level. It is best to check the floor for level before installing the pan. If the floor is not level, float the floor with mortar or other suitable material before setting the pan. Allow this material to dry before setting the pan. After setting the pan, you must check it in all four directions (front to back, side to side and diagonally each direction) and shim the necessary areas to level the pan. **Check the pan by setting the level on top of the curb, not into the base of the pan.** The floor where the pan is to be installed should be clean and free of dust and debris, which could cause the pan to rock.

The plumber should connect the drain to the pan and set the pan in place.

Shower Pan Drain Dimensions

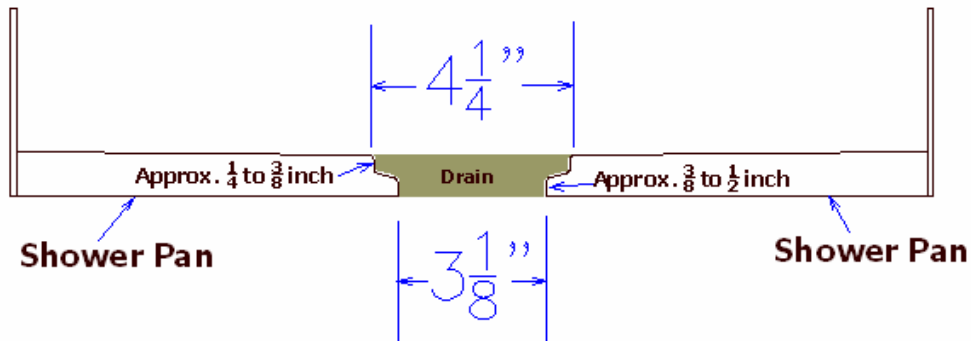

Green board or Durock should not be installed until after the plumber has connected the plumbing to the pan. The green board or Durock should stop about one inch above the fiberglass leak-proof edge of the pan (See attached drawing).

Drawing A:

Standard Pans

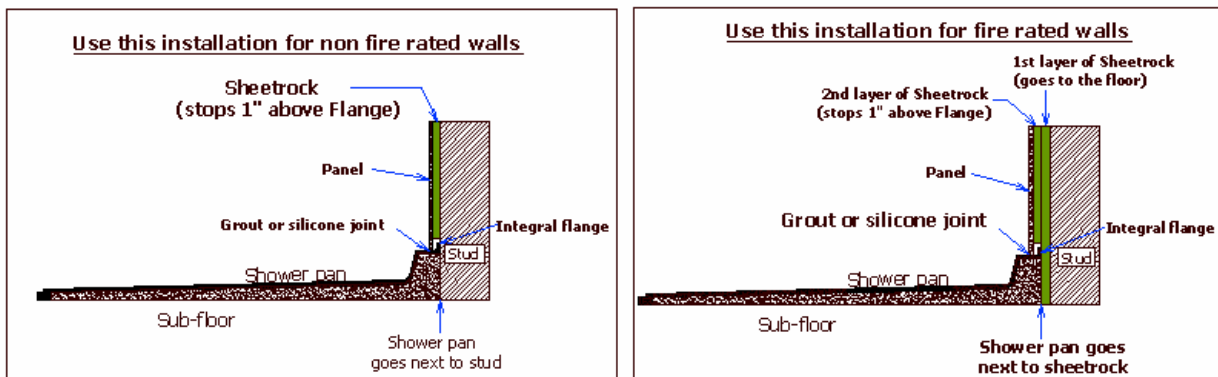

Please call Mincey Marble at 800.533.1806 if you have any questions.